



# ASSEMBLY INSTRUCTIONS for INDOOR CABIN SAUNA

Read these assembly instructions and the accompanying video to enhance your building experience.



[www.leisurecraft.com](http://www.leisurecraft.com)

Other fine products by Leisure Craft



# Table of Contents

Tools Checklist	Pg 4
Sauna Base Preparation	Pg 5
Bottom Frame Assembly	Pg 6-8
Wall Assembly	Pg 9
Door Installation	Pg 10-12
Wall Assembly (Continued)	Pg 13
Wall Top Assembly	Pg 14-15
Roof Top Side Assembly	Pg 16-18
Roof Stave Assembly	Pg 19-20
Corner Trim Installation	Pg 21
Roof Trim Installation	Pg 22-23
Bench Assembly & Installation	Pg 24-27
Interior Trim Installation	Pg 28-29
Accessory Install Section	Pg 30-32
Maintaining Your Sauna	Pg 34
Warranty	Pg 35

# CONGRATULATIONS

on the purchase of your

## Canadian Timber Harmony Sauna

**Just a few things to follow.....**

**Please be sure to read this entire manual  
Before proceeding with the assembly.**

All electrical connections must be performed  
By a qualified electrician.



For further information about your heater and  
Installation instructions, please refer to the  
provided heater manual.



Always ensure that you have the correct screw  
length so that the screw does not go all the way  
through the material and come out the other side.



# Tools Checklist

Ensure you have the following tools to finish the job right!

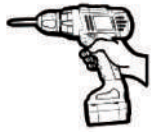

Cordless Driver



Tape Measure



Hammer



Marker or Pencil

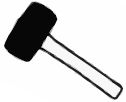

Mallet



1/4" Wrench



Level



Adjustable



Circular Saw,  
Table Saw or Mitre Saw



**#3** Robertson Bit  
(Short bit + 4" or longer)



# Sauna Base Preparation

Ensure the base for your sauna is level with a slight slope to the back for drainage. A solid base for your sauna is recommended and can be made from the following.



Crushed Stone



Patio Stone/Paver Blocks



Concrete Pad

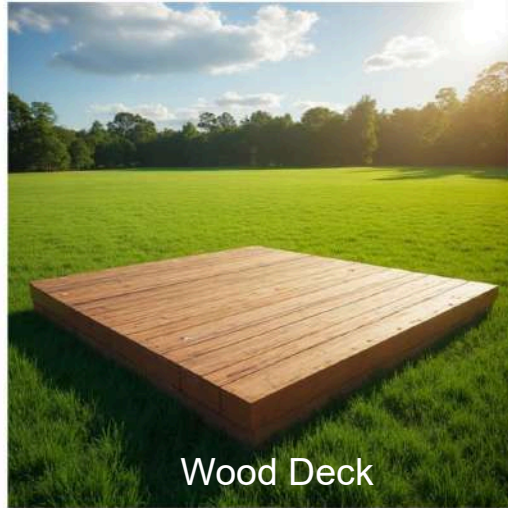

Wood Deck

It is recommended to build a base larger than required to provide a sitting area for cooling off during your sauna session.



# Assembly Instructions

1

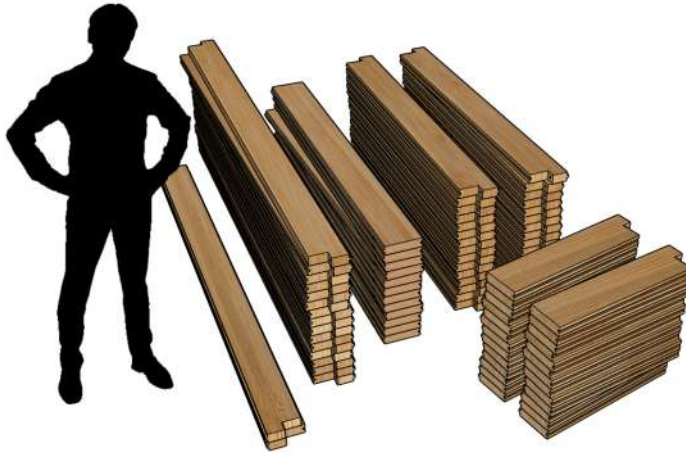

To start the assembly, lay out and organize all of the pieces for your sauna build.

2



Locate the 2 pieces marked "bottom side".

3

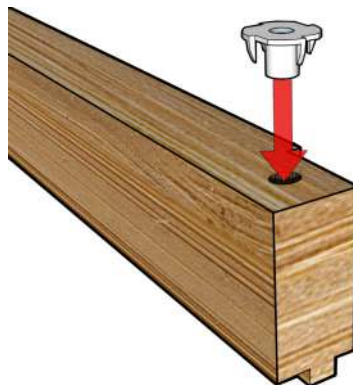

For both boards take a T-Nut and place them on each end of the bottom of the boards (See image above). Tap them in place with a hammer.



## Bottom Frame Assembly

4

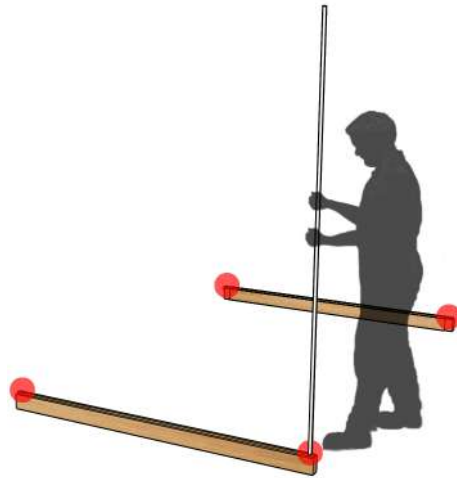
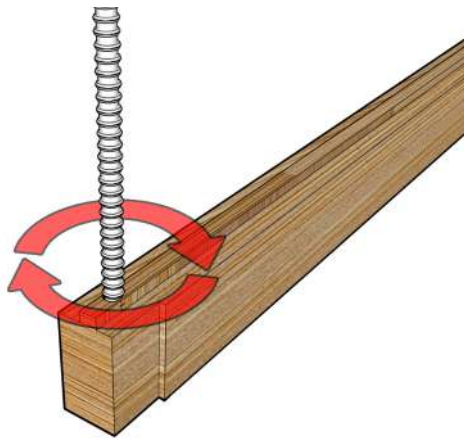

Turn both boards so they are facing upwards. The T-Nuts should be facing the floor. Take the 4 threaded rods and screw them into the pre-drilled holes connected to the t-nuts on the bottom of the floor. Keep turning the rods until they are flush with the bottom.

5

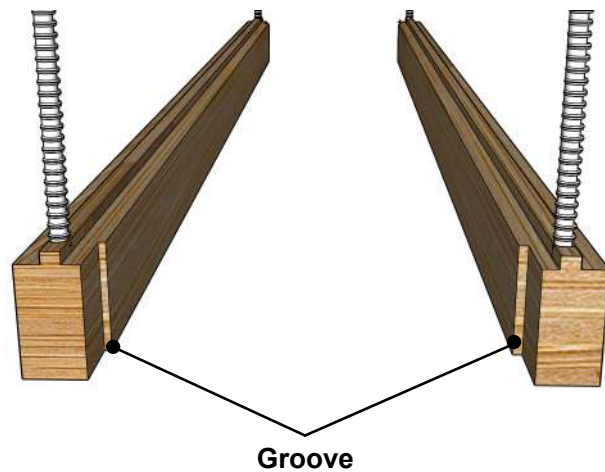
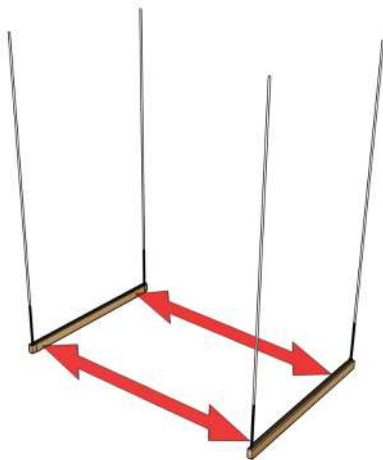

Space both boards approximately 70" apart.

**PLEASE NOTE:** Ensure the grooves in the bottom staves are facing inwards towards each other.



## Bottom Frame Assembly

6



Ensure you wash your hands to prevent grease from the threaded rods getting onto any of the sauna pieces.

7

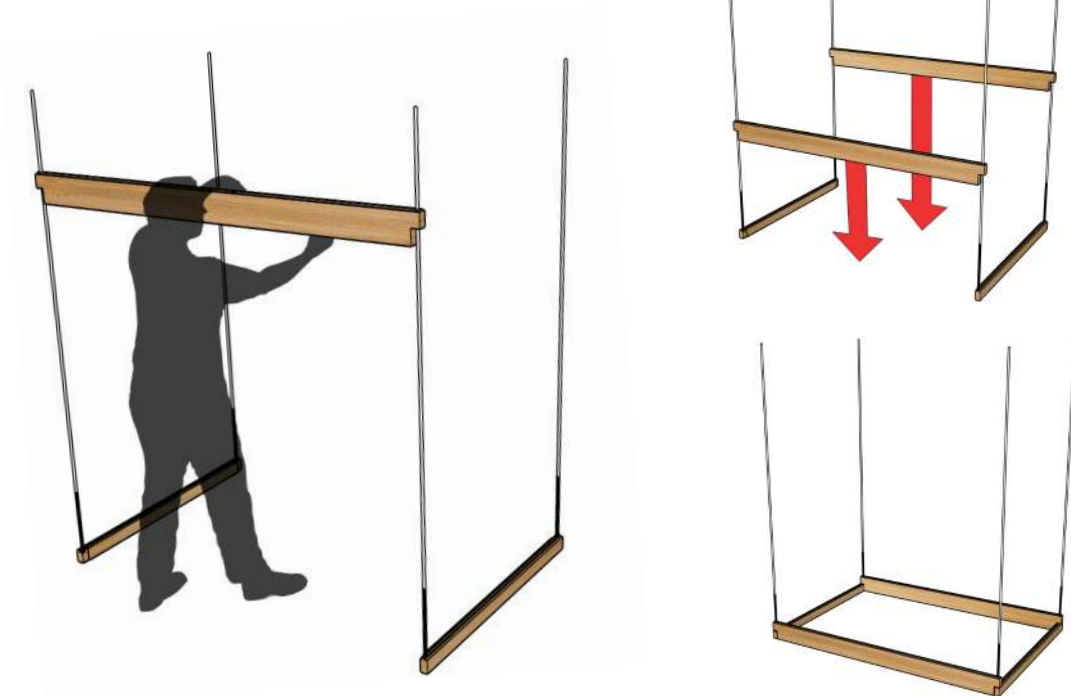

Alternate sliding the front and back bottom staves over the threaded rod and slide down. The front and back bottom staves should be flat on the bottom with the notch facing upwards when placing them on the threaded rods.



## Wall Assembly

8

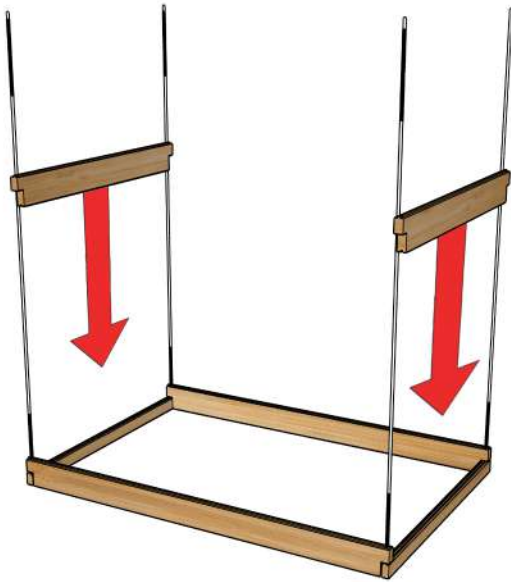

9

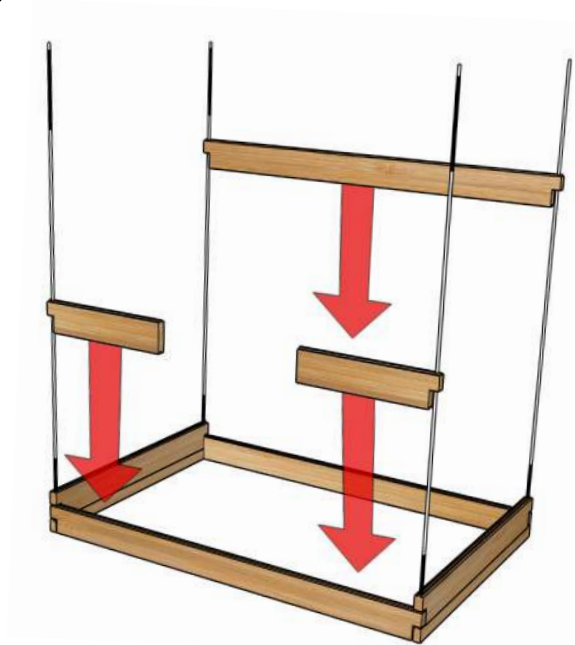

10

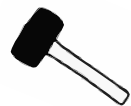
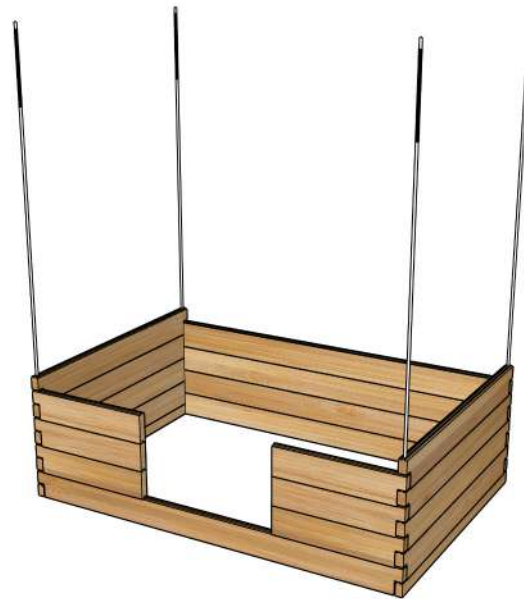

4 rows

Continue adding staves until the 4<sup>th</sup> row is complete. Ensure the sauna is square as you assemble the walls to make future steps easier.



# Door Installation

11

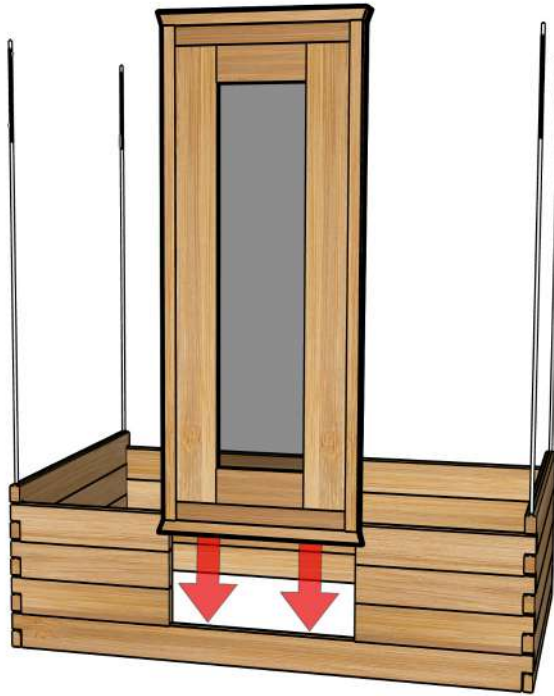

Recommended  
two person job

Carefully slide the groove of the door frame into the front wall staves.

12

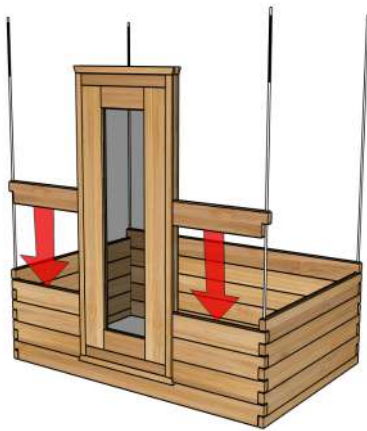

13

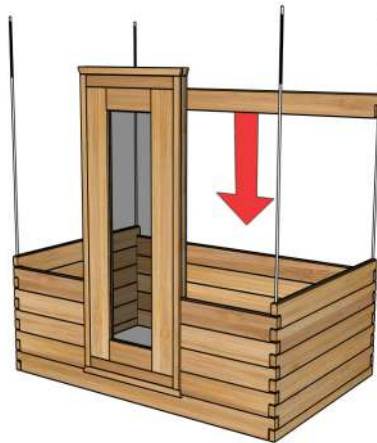

14

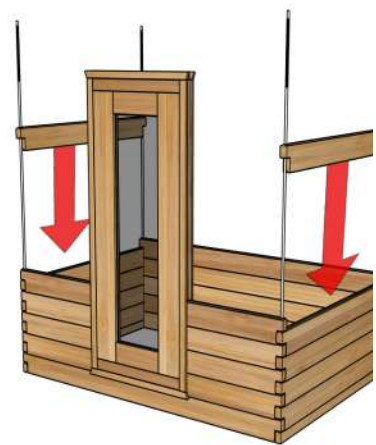

Scan the code for a video of the assembly process:



## Door Installation

15

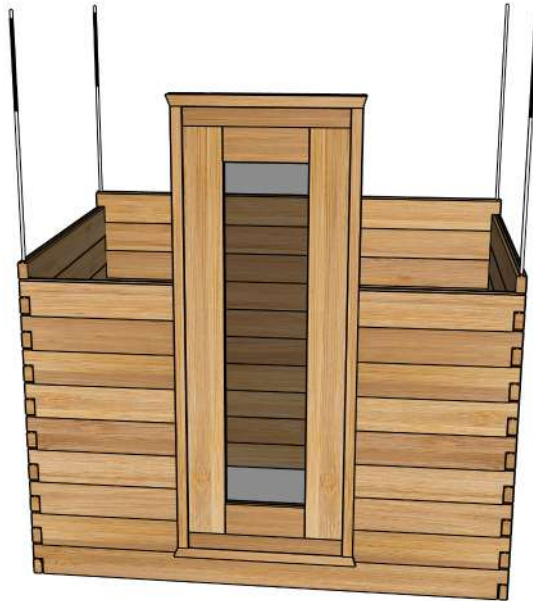

Following **STEPS 12,13 & 14** add wall staves alternating between front, back and side staves. Continue until the walls are built halfway to the top of the sauna.

16



17



To make it easier to get in and out of the sauna during assembly, add the handles to the door.

Place the outer door handle at desired height.

Ensure it is centred.



Scan the code for a video of the assembly process:



# Door Installation

**18**  **2X**  
2 1/2" (64 mm) Robertson

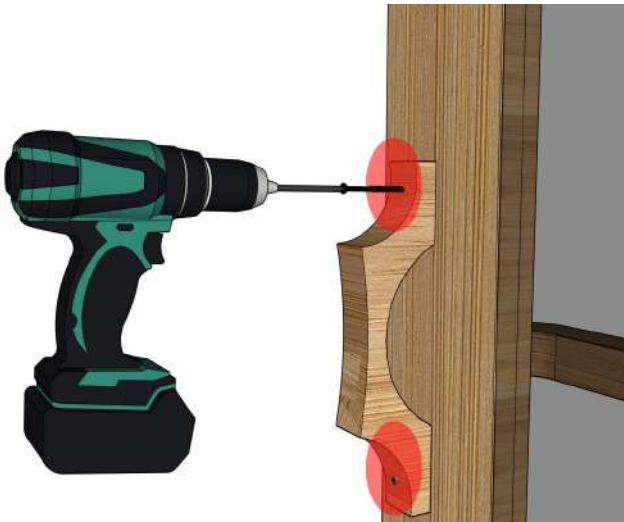

Fasten with 2 screws in the pre-drilled holes .

**19**



Place the inner door handle at desired height and centered.

**20**  **2X**  
2 1/2" (64 mm) Robertson

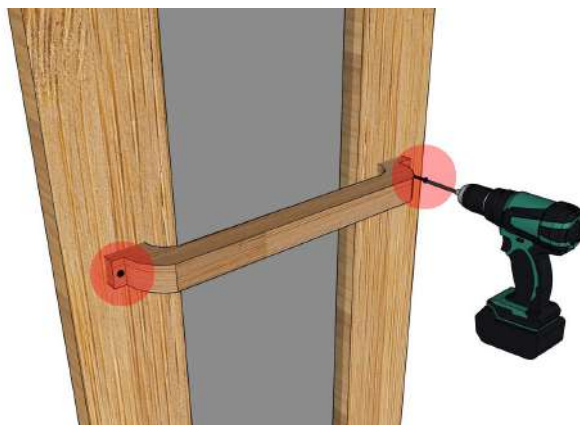

Fasten with 2 screws. Ensure handle is installed level and secure.



## Wall Assembly (Continued)

21

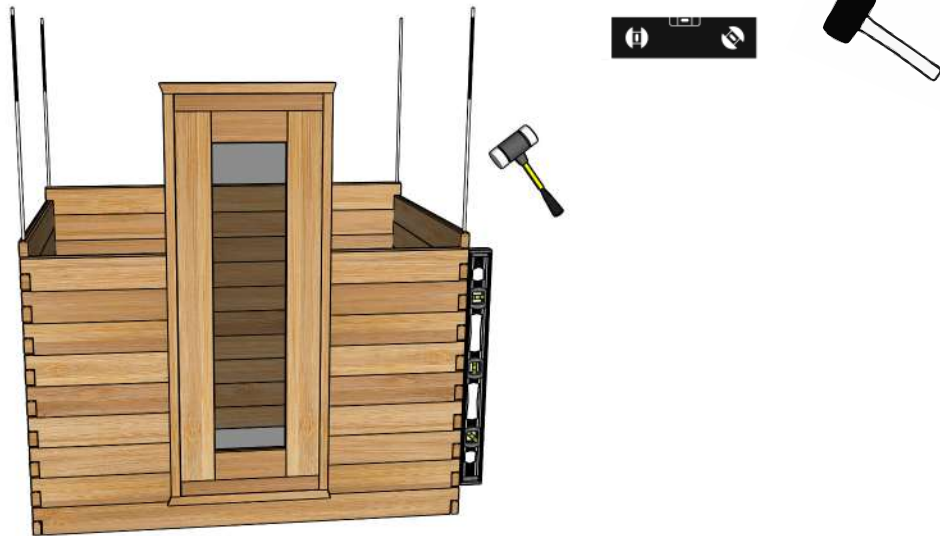

Stop to check that the sauna frame is level and square. Adjust if needed.

22

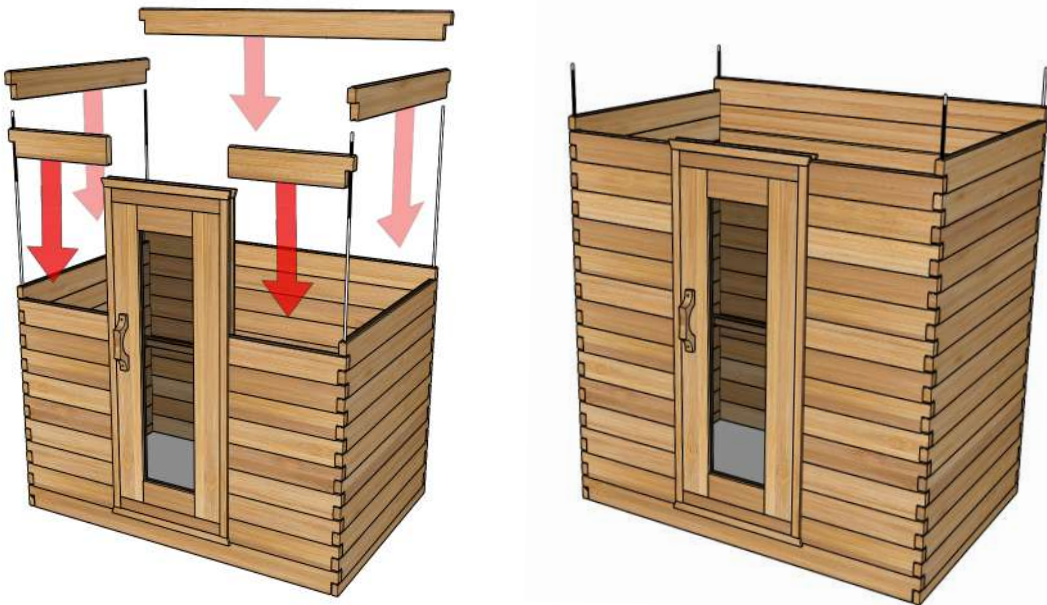

Continue adding staves following **STEPS 12,13 & 14** alternating between adding front, back and side staves. Continue adding staves until you reach near the top of the door.



## Wall Top Assembly

23

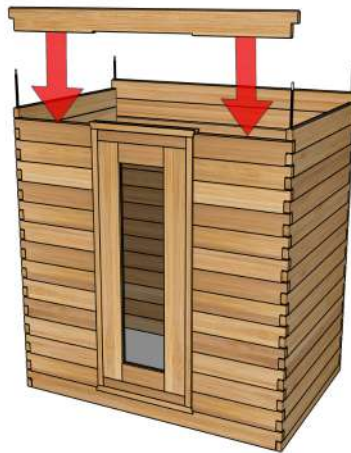

Door Notch

When you have reached near the top of the door frame, insert a full length front wall stave with a door notch. Ensure the door notch is positioned at the bottom of the board.

24

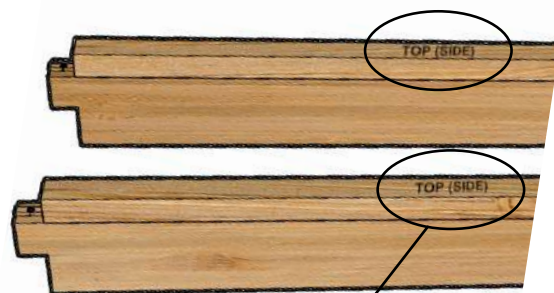
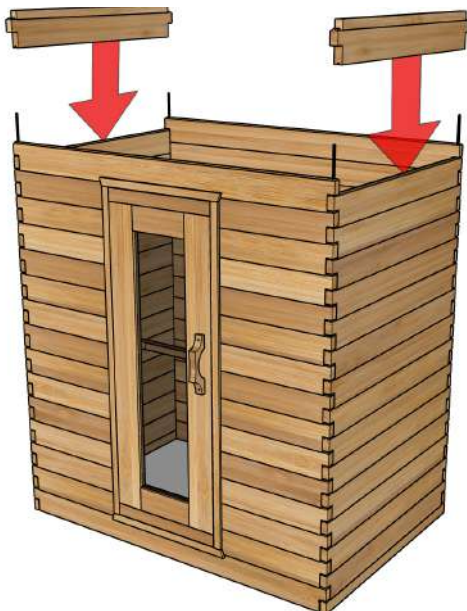

STAVES LABELLED  
TOP(SIDE)

Find and add two staves labelled **TOP(SIDE)**. Install these to the sides of the sauna top.



## Wall Top Assembly

25

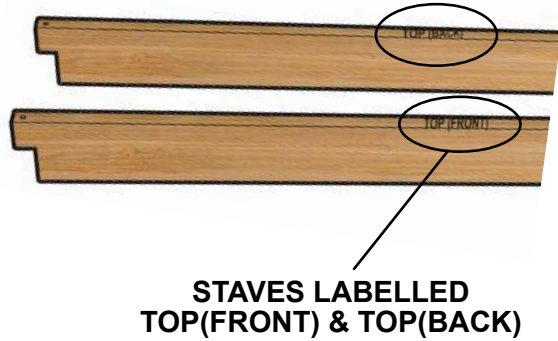
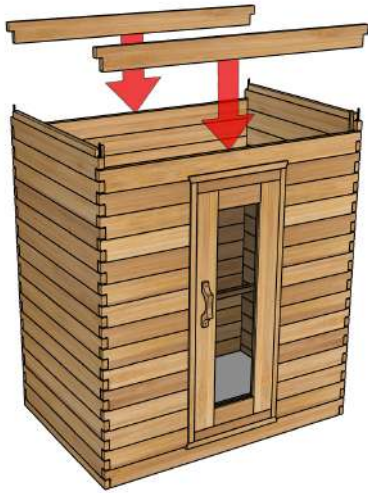

STAVES LABELLED  
TOP(FRONT) & TOP(BACK)

Find and add two staves labelled **TOP(FRONT)** & **TOP(BACK)**.  
Install these to the front and back sides of the sauna top.

26

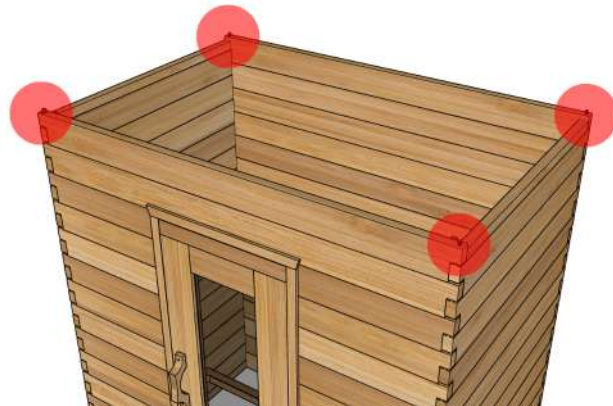
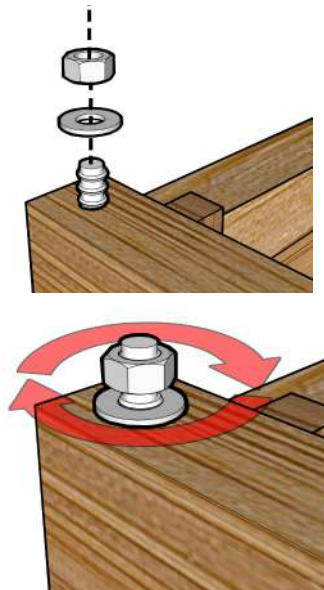
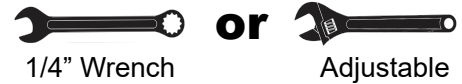

Locate the nuts and washer. Fasten a washer and nut on the top of the threaded rod.  
Ensure that you do not overtighten. Repeat for all threaded rod located on the corners of the sauna.



## Roof Top Side Assembly

27



or

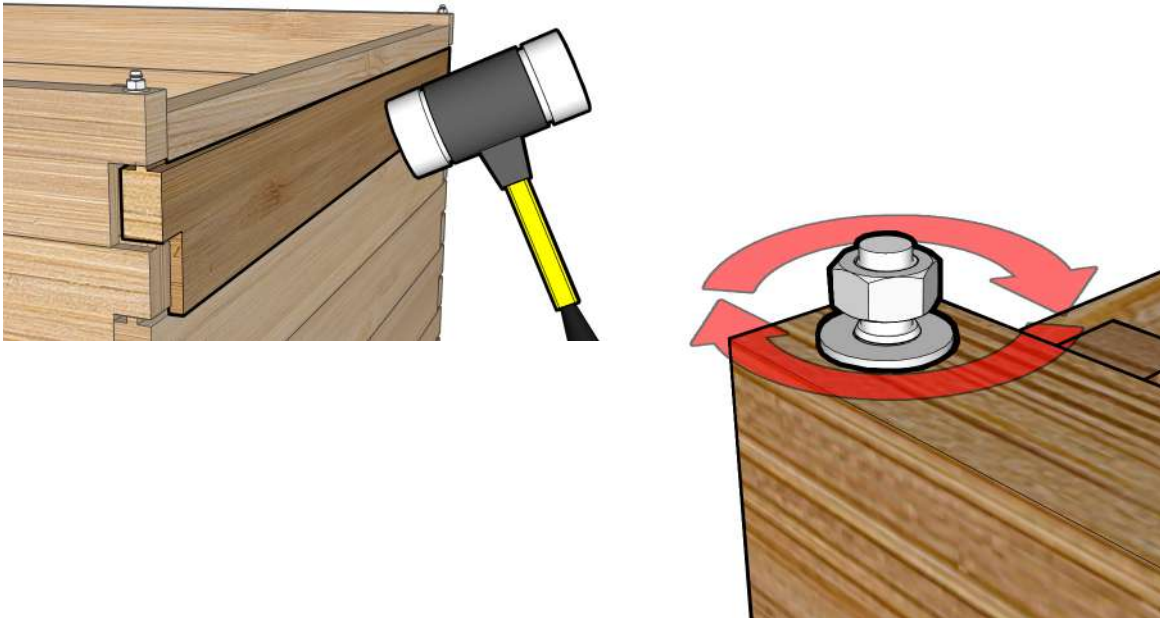

If necessary, use the rubber mallet to correct any warping or slightly out of place staves along each corner of the sauna. Tighten up the 4 nuts a bit more after using the rubber mallet.

28

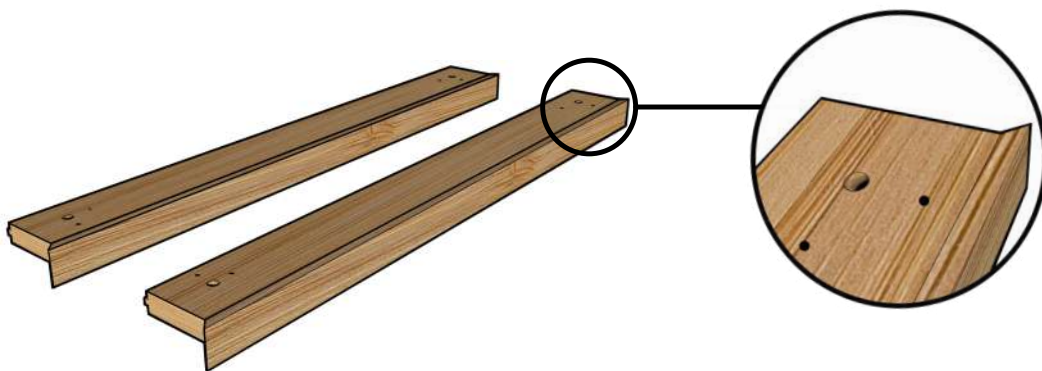

Locate and identify the roof side trim pieces. There will be a large hole near the end of each board.



## Roof Top Side Assembly

29

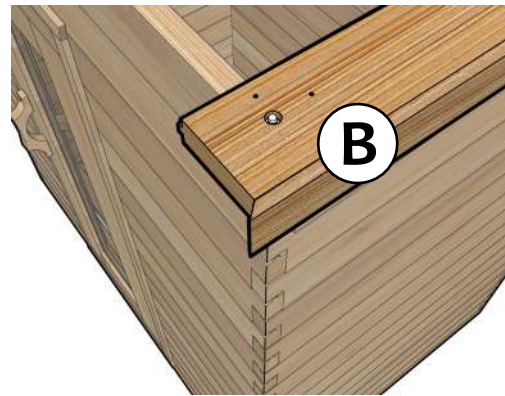
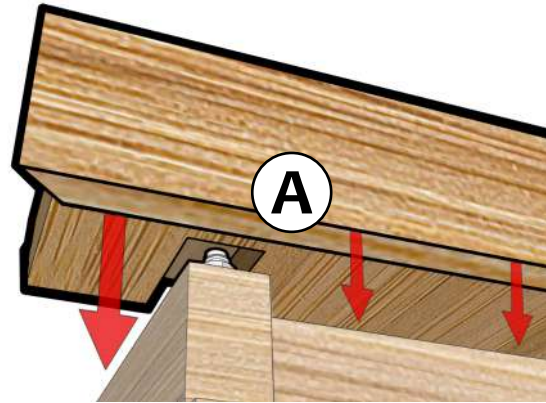

Place the roof side trim on top of the side wall. The notch located on the bottom of each board should fit over the front and back staves (A). The holes on each end of the board will fit over the threaded rods (B).

30

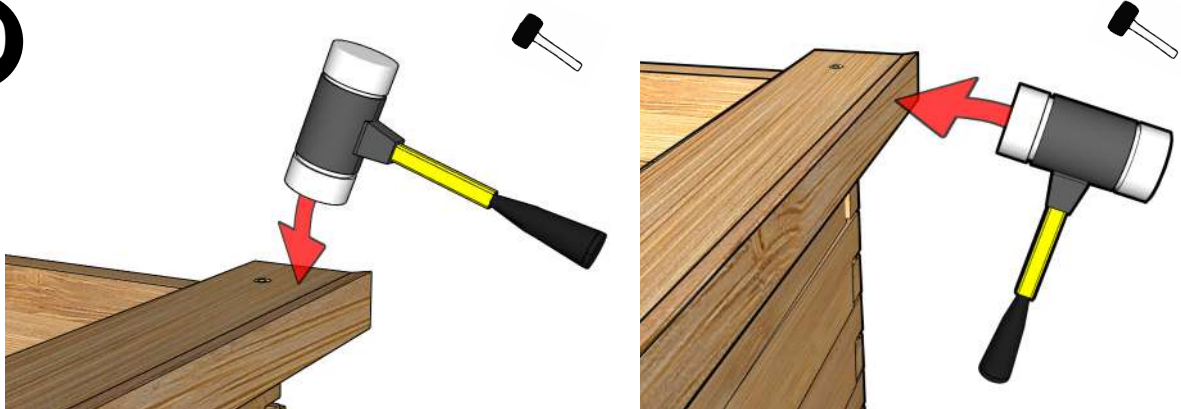

It may be necessary to tap the trim into position for a tight fit.

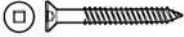

## Roof Top Side Assembly

**31**  **8X**  
2 1/2" (64 mm) Robertson

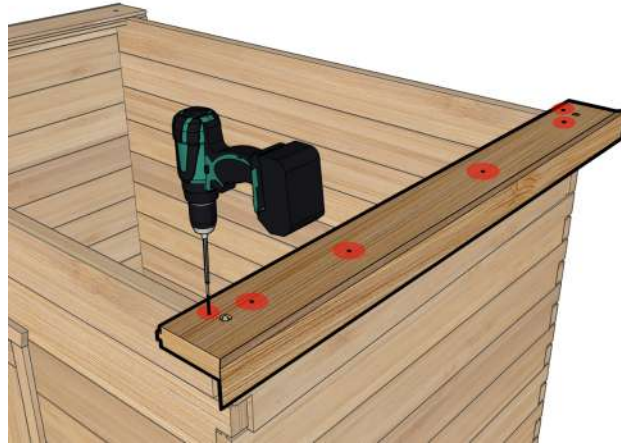
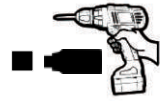

Once in correct position, fasten the roof trim to the side wall using screws in the pre-drilled holes.

**32**

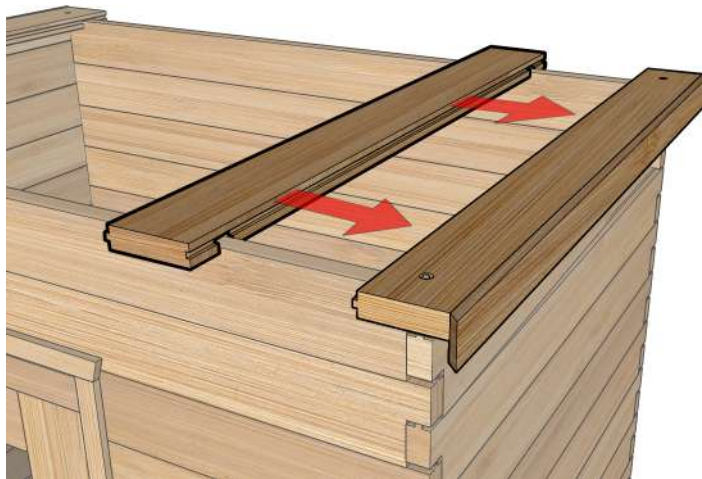

Install a roof stave onto the roof of the sauna by sliding the grooves of the stave over the lip of the front and back walls. Slide the stave until it rests against the roof side trim.



## Roof Stave Assembly

33

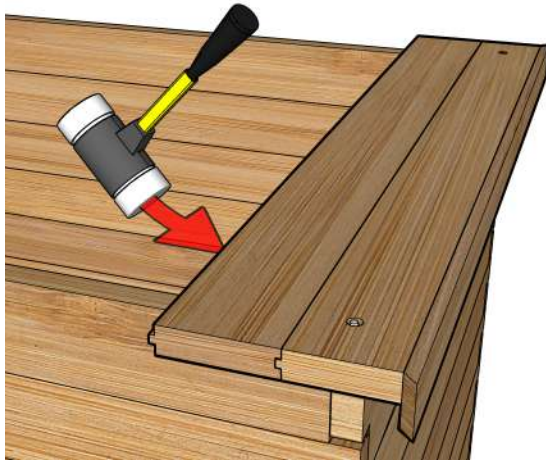

Using the rubber mallet, tap the roof trim into position. Ensure a tight fit between the two staves.

34

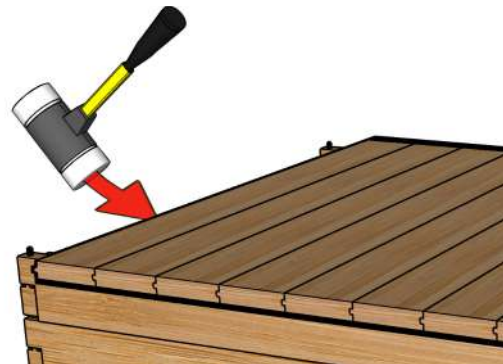
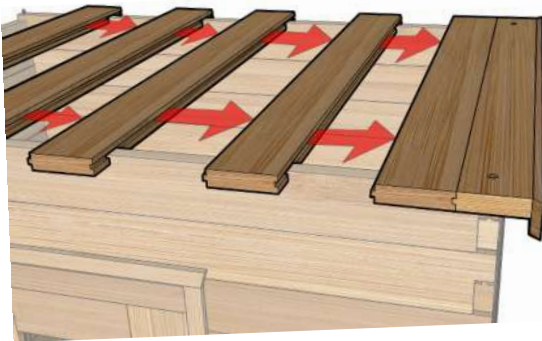

Continue the process of adding staves until you reach the opposite side of the sauna. Use a mallet as necessary to place staves. Ensure a tight fit between staves.



## Roof Stave Assembly

35

 **24X**  
2 1/2" (64 mm) Robertson

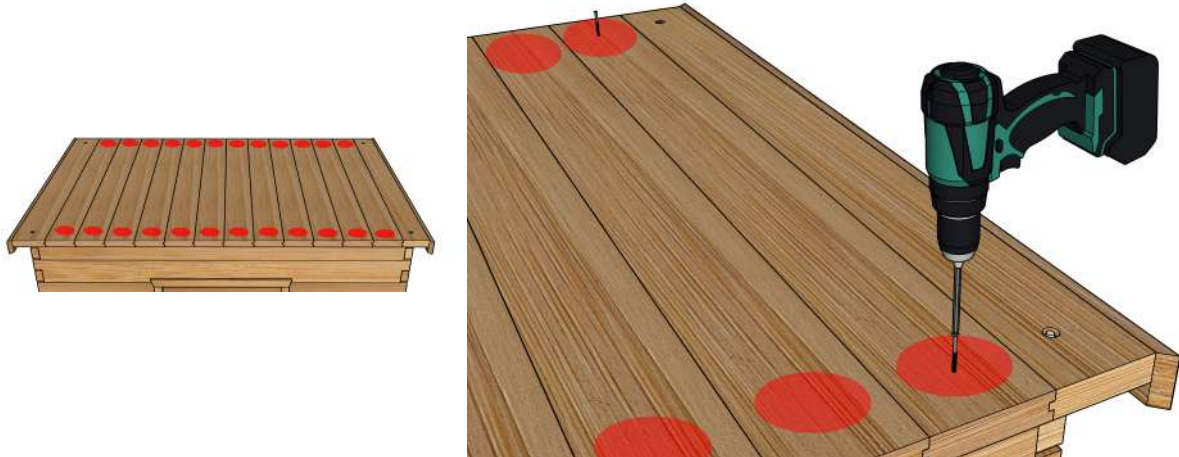
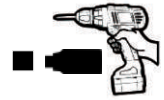

Fasten each stave with a screw at either end of the board.

36

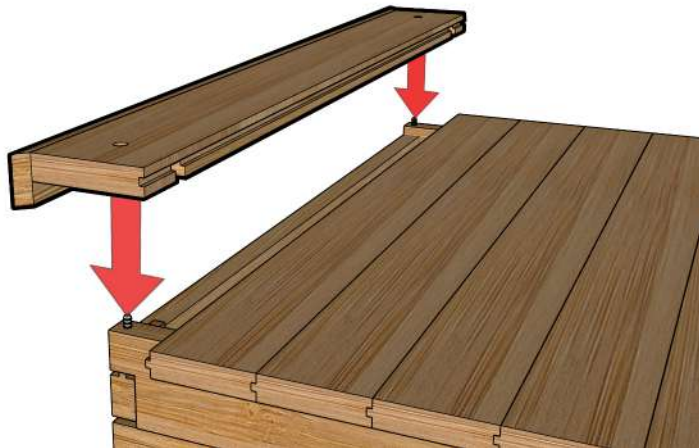

Install the final roof side trim piece following **STEPS 29,30 & 31**.



## Corner Trim Installation

37

 **32X**  
1 1/2" (38 mm) Robertson

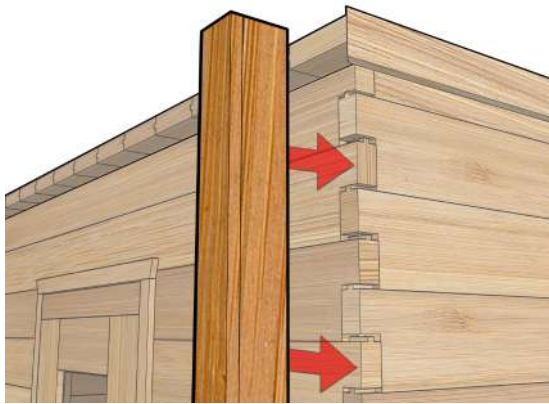
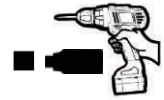

Position and fasten corner trim to the corner with screws.

38



Repeat **STEP 37** for the remaining three corners of the sauna.



# Roof Trim Installation

39

 **8X**  
1 1/2" (38 mm) Robertson

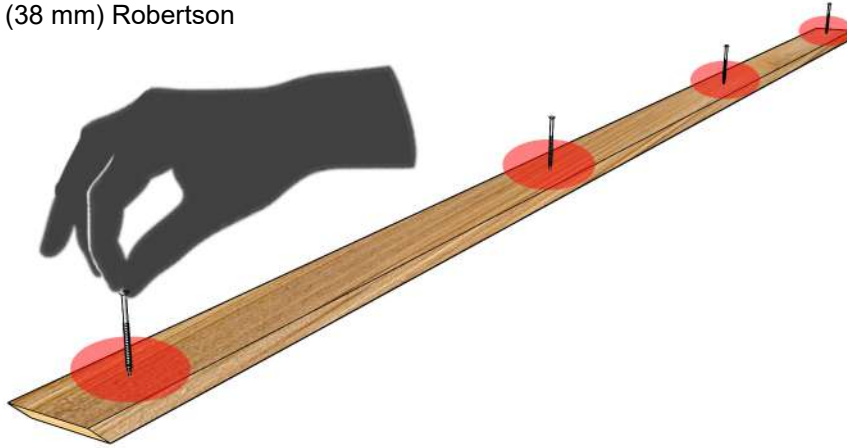

Find the front & back roof trim and pre-screw each piece.

40

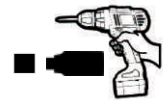
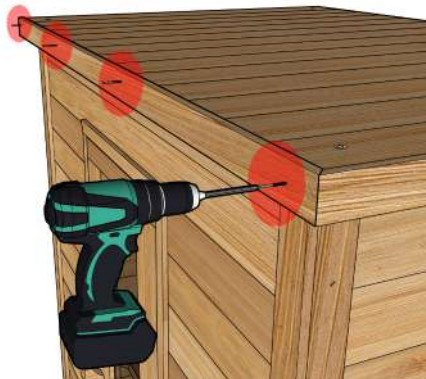
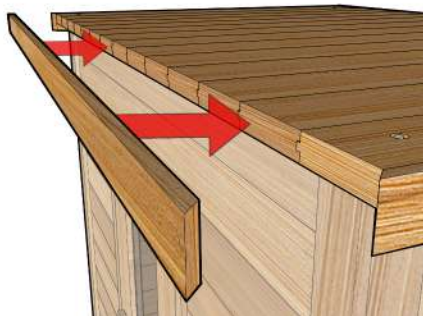

Line the front roof trim with the side trim ensuring they are flush and secure with screws.



## Roof Trim Installation

41



Follow **STEP 40** for the back roof trim.

42

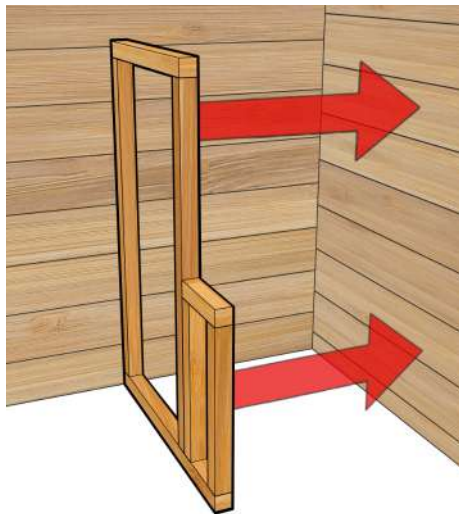

Inside of the sauna, position a bench bracket to the back and side wall (See image above).



## Bench Assembly & Installation

43

 **12X**  
2 1/2" (64 mm) Robertson

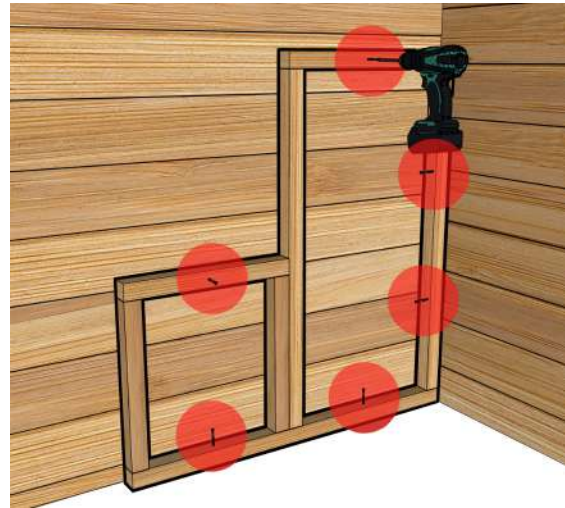

Fasten the rear bench bracket to the back and side wall.  
Follow **STEPS 42-43** for the bench bracket on the opposite wall in the sauna.

44

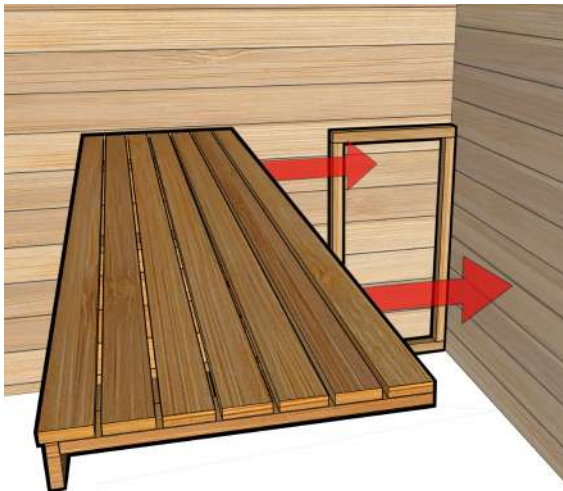

Position the bench top on the bench supports.



## Bench Assembly & Installation

45

 **4X**

1 1/2" (38 mm) Robertson

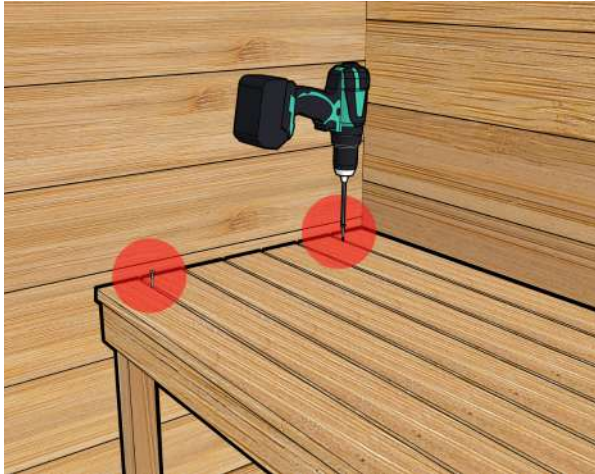
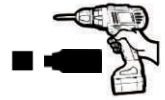

Secure the bench top with two screws over each bench support. Place the screws between the slats to make the screws less visible.

46



Place a third bench bracket underneath the bench top. The bench bracket should be positioned directly below the cross support of the bench top.



# Bench Assembly & Installation

47

 **6X**  
2 1/2" (64 mm) Robertson

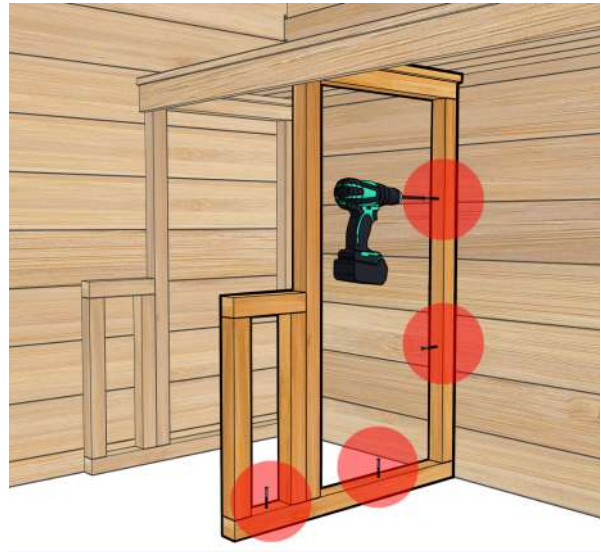
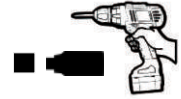

Ensure the bench support is square and tight to the back wall. Secure the bench support to the sauna with screws. Repeat **Steps 46 & 47** for the fourth bench bracket placing it directly below the other cross support of the bench top.

48

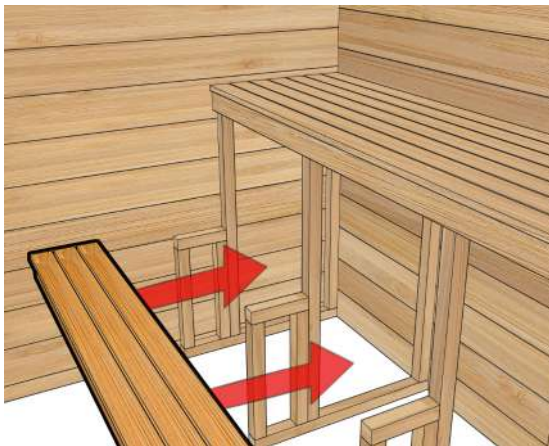

Position the second bench top on the bench supports.



# Bench Assembly & Installation

49

 **8X**

1 1/2" (64 mm) Robertson

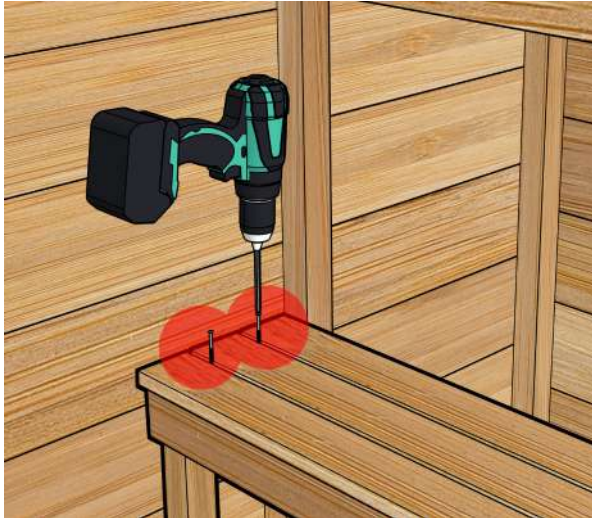
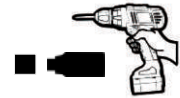

Secure the smaller bench top with two screws for each bench bracket. Place the screws between the slats to make the screws less visible.

50

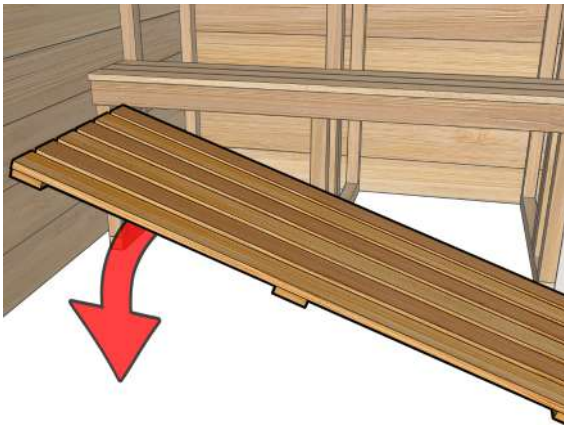

When the bench installation is complete, lay the duckboard floor down in front of the benches.



Scan the code for a video of the assembly process:



# Interior Trim Installation

51



Measure and record the measurement for each of the 4 corners inside the sauna (See image above).

52

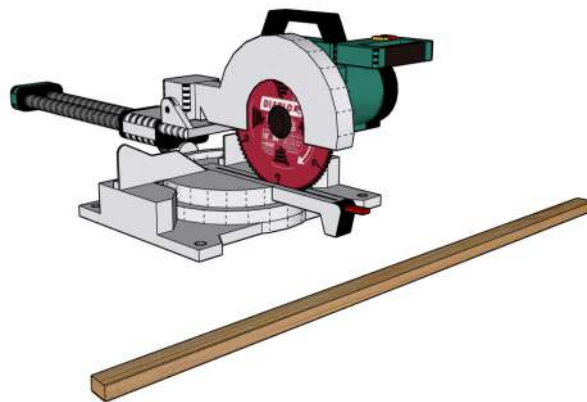

Transfer the measurements to 4 pieces of trim. Cut each trim piece to length.



# Interior Trim Installation

53

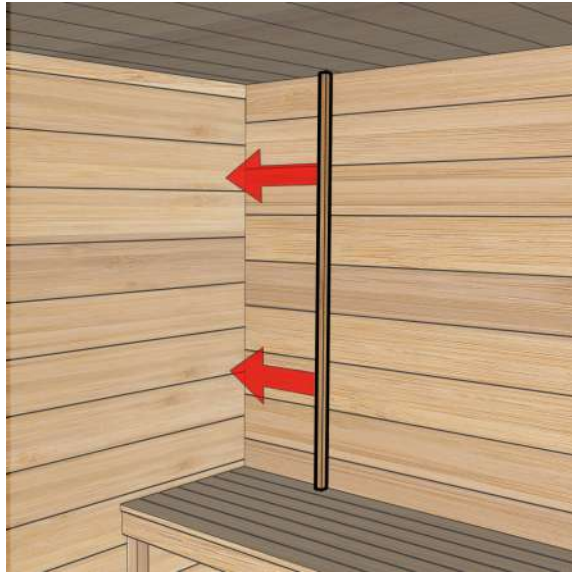

Place each trim piece into the corners of the sauna interior.

54

Finishing Nails



Fasten the trim pieces with provided finishing nails.



## Accessory Install Section



That concludes the basic instructions for the  
**Indoor Sauna Cabin .**

If you have any accessories left to install or will be in the near future please continue on to the next section.

We hope you enjoy your sauna.



# Accessory Install Section

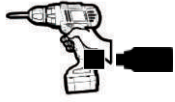

**4X**    
1 1/2" (38 mm) Robertson

**Single Towel Hook**

**55**

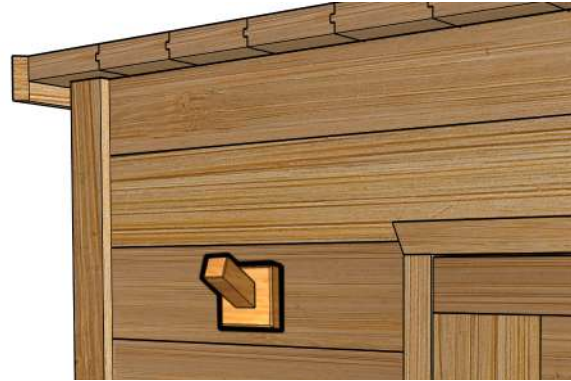
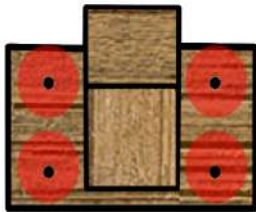

Place the towel hook in desired location and secure with screws in the pre-drilled holes.

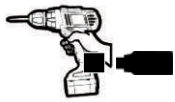

**4X**    
1 1/2" (38 mm) Robertson

**3 Towel Hook**



Place the towel hook in desired location and secure with screws in the pre-drilled holes.



# Accessory Install Section

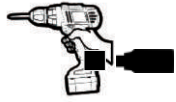

**2X**   
1 1/2" (38 mm) Robertson

Sand Timer (Optional)

**56**



Place the sand timer in the desired location and secure with screws in the pre-drilled holes. Ensure it is in position and level so it may rotate without hitting the wall.



# INTRODUCING OUR SAUNA STAINS & FINISHES

## ALIS NATURAL OIL FOR EXTERIOR WOOD

Perfect for your sauna and garden furniture. This protective oil for outdoor wood offers great value.



Black



Elm Dark Brown



Light Teak



Sesame



## MELDOS NATURAL OIL FOR SAUNA INTERIORS

Meldos is a natural and versatile impregnating, perfect for protecting soft Woods and ideal use in saunas.



See your local paint retailer to purchase your preferred outdoor stains or water sealer or you can try LIVOS wood care products from Leisurecraft today!



Scan the code for a video of the assembly process:



# Maintaining Your Sauna After Installation

## INTERIOR

It is recommended to vacuum or sweep out the inside of your sauna frequently to remove dirt and debris. Under normal conditions, a slight wash of the floor and benches with warm soapy water several times a year will maintain its cleanliness. Leisurecraft offers a sauna room cleaner that can be used pure or diluted at a 4-1 ratio. Simply spray and wipe!

You can use a sheet of fine grit sandpaper or a low-pressure wash to remove more stubborn stains for a deeper cleaning of the interior of your sauna.

**NEVER USE ammonia or harsh cleaners as they can turn the wood gray.**



## EXTERIOR

Depending on the humidity and weather conditions in your area, the cedar will either shrink or expand based on the amount of moisture absorption. The desired effect is to have the cedar expand into the bands therefore making the sauna staves much tighter. Over time the lumber will weather naturally as a result of sun and rain, it will change into a weathered grey colour. The natural weathering will not harm the wood or impair the sauna's performance.

If you wish to retain the natural color of your Leisurecraft Sauna, Leisurecraft offers cedar sauna stain in 4 amazing colors, Espresso, Limestone Trail, Onyx Gem, and Pickled White in convenient 1 gallon pails.

## WATER SEEPAGE

Some minor water seeping into the sauna is expected and normal for an outdoor sauna. If your sauna is properly installed, you should not have water dripping in, but you should expect some water seepage, especially on the top and sides of the sauna. This is due to the porous characteristics of the wood and to the ball-and-socket profile design of the staves. Water seepage will not harm the sauna. The moisture will evaporate once you turn on the heater and the sauna heats up. If the water marks are bothersome, they can be easily removed with a light sanding with 80 or 100 grit sandpaper.



Scan the code for a video of the assembly process:





## 5 Year Residential Limited Warranty Policy

All products designed and manufactured by Dundalk LeisureCraft Inc. ("LeisureCraft") are covered by a limited warranty against defects in materials and workmanship under normal residential use for a period of five (5) years, beginning on the date the product is received by the original end-user consumer.

This warranty does not apply to defects resulting from normal wear and tear, improper installation, insufficient or improper maintenance, natural weather conditions or failure to follow the manufacturer's installation, usage, or care instructions.

In the event of a valid warranty claim, LeisureCraft will provide replacement parts at no charge. However, please note that the replacement of parts will not extend the original warranty period.

This warranty is limited solely to the replacement of parts and does not cover any associated service, labor, or installation costs, all of which are expressly excluded.

For products offered by LeisureCraft that are not manufactured by LeisureCraft, please refer to the warranty policy and terms provided by the manufacturer.

## LIMITED WARRANTY

Dundalk LeisureCraft Inc. ("LeisureCraft") is committed to providing high-quality sauna heaters and accessories to our customers. To offer peace of mind, we will match the manufacturer's warranty on all eligible products purchased from us. If the manufacturer offers a warranty on the product, we will honor that warranty, ensuring the same terms, coverage, and duration.

This warranty is limited to the replacement of parts only. It does not cover any service, labor, or installation costs, which are expressly excluded.

This warranty does not apply to defects caused by normal wear and tear, improper installation, inadequate or improper maintenance, or failure to adhere to the manufacturer's installation, use, or care instructions.

All electrical connections must be made by a licensed electrician. Failure to comply with this requirement will void the warranty.

For warranty claims or inquiries, please contact LeisureCraft customer support at:

Phone: 888-923-9813 Email: [support@leisurecraft.com](mailto:support@leisurecraft.com)

**Please ensure you fill out your warranty card!**





# Leisurecraft

— BUILDING LUXURY —



pure cübe

318448 8<sup>th</sup> Line Melancthon, Ontario  
L9V 2K3 Canada

Phone: 519.923.9813  
Toll Free: 888.923.9813  
Fax: 866.458.7583

Check us on



Info@leisurecraft.com  
www.leisurecraft.com